



Owner's Manual

◆ SET-UP ◆ OPERATION ◆ MAINTENANCE



IMPORTANT: Read Safety Rules and Instructions Carefully

CALLING CUSTOMER SUPPORT

- **LOCATE YOUR MODEL NUMBER AND SERIAL NUMBER** which appears on your unit and record the information in the space provided below.

IMPORTANT: You must have these numbers, along with the date and proof of purchase to receive warranty or service.

- If you are having difficulty assembling this product or if you have any questions regarding the controls, operation or maintenance of this unit, please call an authorized dealer.
- Please have your model number and serial number ready when you call.

NOTE: Although both numbers are important, you will be asked to enter only your serial number before your call can be processed.

Model Number Numéro de modèle XXX-XXXXXX	Serial Number Numéro de série XXXXXXXXXXXX
--	--

TROY-BILT TROYBILT - CANADA
 KITCHENER, ON N2G 4J1

This is where your model number will be, record model number here:

This is where your serial number will be, record serial number here:

TABLE OF CONTENTS

CALLING CUSTOMER SUPPORT	2
TABLE OF CONTENTS	2
IMPORTANT SAFE OPERATION PRACTICES	3
SLOPE GAUGE	6
UNPACKING	7
CONTENTS OF HARDWARE PACK	7
OPERATION	10
ADJUSTMENT	11
LUBRICATION	12
MAINTENANCE	12
OFF SEASON STORAGE INSTRUCTIONS	13
REPLACEMENT PARTS/PIÈCES DÉTACHÉES	14
WARRANTY	17

This unit has been inspected against the manufacturers quality check list. In case of a discrepancy, please call us. We will make every effort to ship the part(s) by courier within one working day of your call.

IMPORTANT SAFE OPERATION PRACTICES



WARNING: This symbol points out important safety instructions which, if not followed, could endanger the personal safety and/or property of yourself and others. Read and follow all instructions in this manual before attempting to operate this machine. Failure to comply with these instructions may result in personal injury. When you see this symbol—  heed its warning.



DANGER: This machine was built to be operated according to the rules for safe operation in this manual. As with any type of power equipment, carelessness or error on the part of the operator can result in serious injury. This machine is capable of amputating hands and feet and throwing objects. Failure to observe the following safety instructions could result in serious injury or death.

GENERAL OPERATION

- Read, understand, and follow all instructions on the machine and in the manual(s) before attempting to assemble and operate. Keep this manual in a safe place for future and regular reference and for ordering replacement parts.
- Be familiar with all controls and their proper operation. Know how to stop the machine and disengage them quickly.
- Never allow children under 14 years old to operate this machine. Children 14 years old and over should read and understand the operation instructions and safety rules in this manual and should be trained and supervised by a parent.
- Never allow adults to operate this machine without proper instruction.
- To help avoid blade contact or a thrown object injury, keep bystanders, helpers, children and pets at least 75 feet from the machine while it is in operation. Stop machine if anyone enters the area.
- Thoroughly inspect the area where the equipment is to be used. Remove all stones, sticks, wire, bones, toys and other foreign objects which could be tripped over or picked up and thrown by the blade. Thrown objects can cause serious personal injury.
- Plan your mowing pattern to avoid discharge of material toward roads, sidewalks, bystanders and the like. Also, avoid discharging material against a wall or obstruction which may cause discharged material to ricochet back toward the operator.
- Always wear safety glasses or safety goggles during operation and while performing an adjustment or repair to protect your eyes. Thrown objects which ricochet can cause serious injury to the eyes.
- Wear sturdy, rough-soled work shoes and close-fitting slacks and shirts. Shirts and pants that cover the arms and legs and steel-toed shoes are recommended. Never operate this machine in bare feet, sandals, slippery or light weight (e.g. canvas) shoes.
- Many injuries occur as a result of the mower being pulled over the foot during a fall caused by slipping or tripping. Do not hold on to the mower if you are falling; release the handle immediately.
- Never pull the mower back toward you while you are walking. If you must back the mower away from a wall or obstruction first look down and behind to avoid tripping and then follow these steps:
 - a) Step back from the mower to fully extend your arms.
 - b) Be sure you are well balanced with sure footing.
 - c) Pull the mower back slowly, no more than half way toward you.
 - d) Repeat these steps as needed.
- Do not operate the mower while under the influence of alcohol or drugs.
- Do not put hands or feet near rotating parts or under the cutting deck. Contact with the blade can amputate hands and feet.
- A missing or damaged discharge cover can cause blade contact or thrown object injuries.
- Do not engage the self-propelled mechanism on units so equipped while starting engine.
- Never attempt to make a wheel or cutting height adjustment while the engine is running.
- The blade control handle is a safety device. Never attempt to bypass its operation. Doing so makes the safety device inopera-

tive and may result in personal injury through contact with the rotating blade. The blade control handle must operate easily in both directions and automatically return to the disengaged position when released.

- Never operate the mower in wet grass. Always be sure of your footing. A slip and fall can cause serious personal injury. If you feel you are losing your footing, release the blade control handle immediately and the blade will stop rotating within three seconds.
- Mow only in daylight or in good artificial light. Walk, never run.
- Stop the blade when crossing gravel drives, walks or roads.
- If the equipment should start to vibrate abnormally, stop the engine and check immediately for the cause. Vibration is generally a warning of trouble.
- Shut the engine off and wait until the blade comes to a complete stop before removing the grass catcher or unclogging the chute. The cutting blade continues to rotate for a few seconds after the engine is shut off. Never place any part of the body in the blade area until you are sure the blade has stopped rotating.
- Never operate mower without proper trail shield, discharge cover, grass catcher, blade control handle or other safety protective devices in place and working. Never operate mower with damaged safety devices. Failure to do so, can result in personal injury.
- Muffler and engine become hot and can cause a burn. Do not touch.
- Only use parts and accessories made for this machine by the manufacturer. Failure to do so, can result in personal injury.
- If situations occur which are not covered in this manual, use care and good judgment. Contact your customer support department.

SLOPE OPERATION

Slopes are a major factor related to slip and fall accidents which can result in severe injury. Operation on slopes requires extra caution. If you feel uneasy on a slope, do not mow it. For your safety, use the slope gauge included as part of this manual to measure slopes before operating this unit on a sloped or hilly area. If the slope is greater than 15 degrees, do not mow it.

DO:

- Mow across the face of slopes; never up and down. Exercise extreme caution when changing direction on slopes. Watch for holes, ruts, bumps, rocks, or other hidden objects which can cause you to slip or trip. Tall grass can hide obstacles. Always be sure of your footing. A slip and fall can cause serious personal injury. If you feel you are losing your balance, release the blade control handle immediately, and the blade will stop rotating within 3 seconds.

DO NOT:

- Do not mow near drop-offs, ditches or embankments, you could lose your footing or balance.
- Do not mow slopes greater than 15 degrees as shown on the slope gauge.
- Do not mow on wet grass. Unstable footing could cause slipping.

CHILDREN

- Tragic accidents can occur if the operator is not alert to the presence of children. Children are often attracted to the mower and the mowing activity. They do not understand the dangers. Never assume that children will remain where you last saw them.
 - a) Keep children out of the mowing area and under the watchful care of a responsible adult other than the operator.
 - b) Be alert and turn mower off if a child enters the area.
 - c) Before and while moving backwards, look behind and down for small children.
 - d) Use extreme care when approaching blind corners, doorways, shrubs, trees, or other objects that may obscure your vision of a child who may run into the mower.
 - e) Keep children away from hot or running engines. They can suffer burns from a hot muffler.
 - Never allow children under 14 years old to operate a power mower. Children 14 years old and over should read and understand the operation instructions and safety rules in this manual and should be trained and supervised by a parent.
- ## **SERVICE SAFE HANDLING OF GASOLINE:**
- To avoid personal injury or property damage use extreme care in handling gasoline. Gasoline is extremely flammable and the vapors are explosive. Serious personal injury can occur when gasoline is spilled on yourself

or your clothes which can ignite. Wash your skin and change clothes immediately.

- a) Use only an approved gasoline container.
- b) Never fill containers inside a vehicle or on a truck or trailer bed with a plastic liner. Always place containers on the ground away from your vehicle before filling.
- c) When practical, remove gas-powered equipment from the truck or trailer and refuel it on the ground. If this is not possible, then refuel such equipment on a trailer with a portable container, rather than from a gasoline dispenser nozzle.
- d) Keep the nozzle in contact with the rim of the fuel tank or container opening at all times until fueling is complete. Do not use a nozzle lock-open device.
- e) Extinguish all cigarettes, cigars, pipes and other sources of ignition.
- f) Never fuel machine indoors.
- g) Never remove gas cap or add fuel while the engine is hot or running. Allow engine to cool at least two minutes before refueling.
- h) Never over fill fuel tank. Fill tank to no more than $\frac{1}{2}$ inch below bottom of filler neck to provide space for fuel expansion.
- i) Replace gasoline cap and tighten securely.
- j) If gasoline is spilled, wipe it off the engine and equipment. Move unit to another area. Wait 5 minutes before starting the engine.
- k) Never store the machine or fuel container inside where there is an open flame, spark or pilot light as on a water heater, space heater, furnace, clothes dryer or other gas appliances.
- l) To reduce fire hazard, keep machine free of grass, leaves, or other debris build-up. Clean up oil or fuel spillage and remove any fuel soaked debris.
- m) Allow machine to cool at least 5 minutes before storing.

GENERAL SERVICE:

- Never run an engine indoors or in a poorly ventilated area. Engine exhaust contains carbon monoxide, an odorless and deadly gas.
- Before cleaning, repairing, or inspecting, make certain the blade and all moving parts have stopped. Disconnect the spark plug wire and ground against the engine to prevent unintended starting.
- Check the blade and engine mounting bolts at frequent intervals for proper tightness. Also, visually inspect blade for damage (e.g., bent, cracked, worn) Replace blade with the original equipment manufacturer's (O.E.M.) blade only, listed in this manual. "Use of parts which do not meet the original equipment specifications may lead to improper performance and compromise safety!"
- Mower blades are sharp and can cut. Wrap the blade(s) or wear gloves, and use extra caution when servicing them.
- Keep all nuts, bolts, and screws tight to be sure the equipment is in safe working condition.
- Never tamper with safety devices. Check their proper operation regularly.
- After striking a foreign object, stop the engine, disconnect the spark plug wire and ground against the engine. Thoroughly inspect the mower for any damage. Repair the damage before starting and operating the mower.
- Grass catcher components, discharge cover, and trail shield are subject to wear and damage which could expose moving parts or allow objects to be thrown. For safety protection, frequently check components and replace immediately with original equipment manufacturer's (O.E.M.) parts only, listed in this manual. "Use of parts which do not meet the original equipment specifications may lead to improper performance and compromise safety!"
- Do not change the engine governor setting or overspeed the engine. The governor controls the maximum safe operating speed of the engine.
- Maintain or replace safety and instruction labels, as necessary.
- Observe proper disposal laws and regulations. Improper disposal of fluids and materials can harm the environment.

SI-102
7.23.03



WARNING - Your Responsibility:
Restrict the use of this power machine to persons who read, understand and follow the warnings and instructions in this manual and on the machine.

SLOPE GAUGE

(Keep this sheet in a safe place for future reference.)

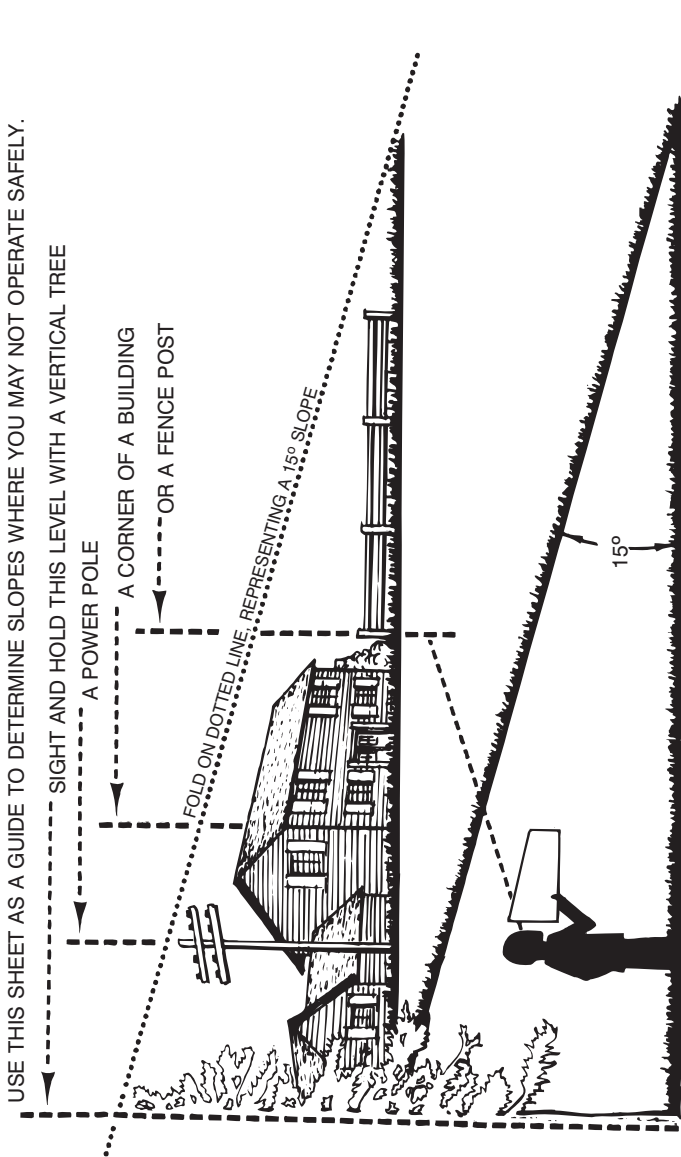

⚠ DANGER

Do not mow on inclines with a slope in excess of 15 degrees (a rise of approximately 2½ feet every 10 feet). A riding mower could overturn and cause serious injury. If operating a walk-behind mower on such a slope, it is extremely difficult to maintain your footing and you could slip, resulting in serious injury.

Operate RIDING mowers up and down slopes, never across the face of slopes.

Operate WALK-BEHIND mowers across the face of slopes, never up and down slopes.

CONTENTS OF HARDWARE PACK

Lay out the hardware according to the illustration for identification purposes. Part numbers are shown in parentheses. (Some parts may not be required for your unit.)

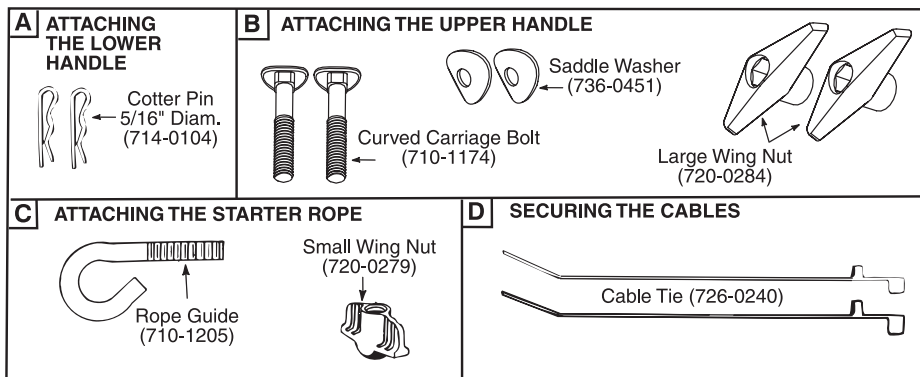

It is suggested that this manual be read in its entirety before attempting to assemble or operate. Keep this manual in a safe place for future reference and for ordering replacement parts.

This unit is shipped **WITHOUT GASOLINE or OIL**. After assembly, service engine with gasoline and oil as instructed in the separate engine manual packed with your unit.

Your mower is a precision piece of power equipment, not a play thing. Therefore, exercise extreme caution at all times.

Tools Required for Assembly

- (1) 9/16" Wrench
(required only if wheels are unassembled)

UNPACKING

- Remove the lawn mower and all parts from the carton. Make certain all parts and literature have been removed from the carton before the carton is discarded.

CAUTION: Disconnect spark plug wire. If the wire is not equipped with a rubber boot, see separate engine manual for grounding procedure.

CAUTION: DO NOT BEND OR KINK CONTROL WIRE.

- Refer to "Contents of Hardware Pack" for hardware identification.

ATTACHING THE LOWER HANDLE (Hardware A)

- There is an off-set hole in the lower handle to provide you with two handle height adjustments. Handles mounted with the notch (see inset, Figure 1) forward or upward will be lower than handles mounted with the notch towards the rear of the unit.
- Place the lower handle assembly on the mower. The holes in the handle fit over the pins on the deck bracket.
- Secure with cotter pins in the inner holes in the weld pins. See Figure 1.

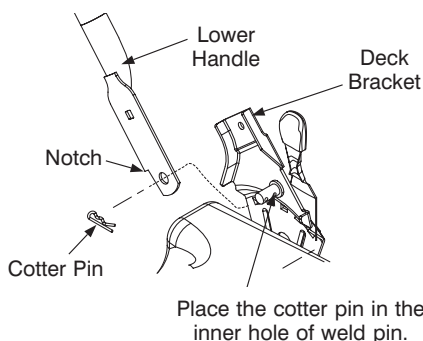

Figure 1

ATTACHING THE UPPER HANDLE (Hardware B)

- Place the upper handle in position over the lower handle. The blade control must be on the upper side of the handle and the control box should be on the left side.

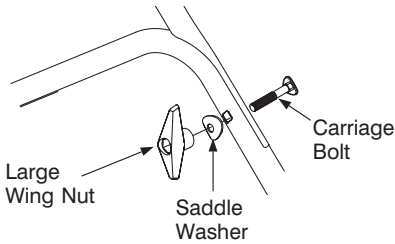

Figure 2

- Secure the upper handle to the lower handle using curved carriage bolts, saddle washers and large wing nuts, see Figure 2.

NOTE: Wing nuts should be mounted on the inside.

ATTACHING THE BLADE CONTROL CABLE

- Make certain the blade control handle is on the top of the upper handle.
- The brake cable is attached to the engine, and has a "Z" fitting on the loose end. Route the brake cable over the lower handle. Snap the plastic fitting into the hole on the **inside** of the upper handle as shown in Figure 3.
- Move the blade control handle away from the upper handle. Hook the "Z" end of the brake cable into the hole in the blade control handle from the outside to the inside as shown in Figure 4.

WARNING: Brake cable must be assembled as shown for proper blade brake operation.

ATTACHING THE STARTER ROPE (Hardware C)

- The starter rope is inside the top of the engine. Additional rope may be wound around the starter handle, so the opening in the rope guide is toward the front of the mower as shown. Insert the rope guide into the right side of the handle.
- Secure with small wing nut. See Figure 5.

NOTE: If the starter rope becomes disconnected from rope guide on handle, **disconnect and ground the spark plug wire.** Depress the blade control handle and pull the starter rope out

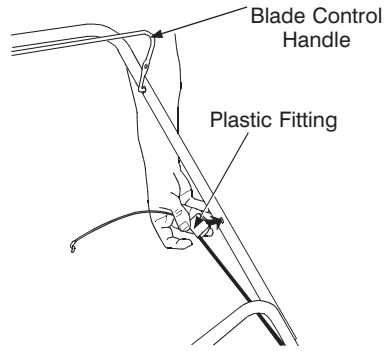

Figure 3

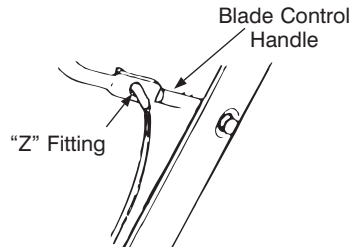

Figure 4

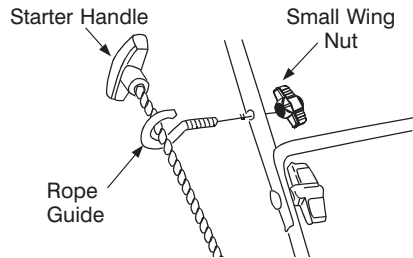

Figure 5

from engine slowly. Slip the starter rope into the rope guide bolt on handle.

SECURING THE CABLE (Hardware D)

Secure the cable to the left side of the handle as follows:

WARNING: When attaching the control cable, the cable must be routed to avoid contact with all sharp edges and hot surfaces to prevent damage to the cable, which will render the control inoperative.

- Insert posts on cable ties into holes provided on the handle, one on the upper handle and one on the lower handle. The holes may be either on the inside or outside of the handles. See Figure 6.

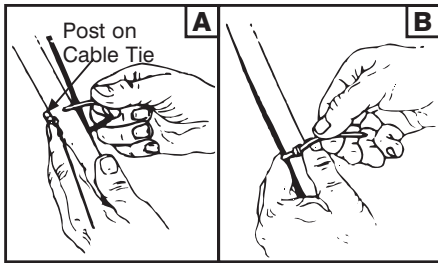

Figure 6

- Secure the cable with the cable ties. See Figure 6. Trim excess ends of cable ties.

INSTALLATION OF WHEELS

- Remove the hex flange locknuts from the pivot arms.

NOTE: The wave washer is only required for models with ball bearing wheels and should remain next to the pivot bar.

- Attach the wheels to the pivot arms on the height adjusters with hex flange locknuts previously removed. See Figures 7 and 8.
- Tighten all wheel hardware.

FINAL ASSEMBLY OF MOWER

Make certain all nuts and bolts are tightened securely.

CAUTION: Do not run your lawn mower without chute deflector or an approved grass catcher in place. The deflector will deflect a projectile thrown by the blade into the lawn.

CHUTE DEFLECTOR (See Figure 9)

- The chute deflector on your mower may be held in an upright position by a block for shipping purposes only. This shipping block must be removed and discarded before the mower is put into operation. See Figure 9.

To remove the shipping block, pull the spring-loaded chute toward the engine. Remove the block and carefully lower the chute into operating position, keeping fingers out of the way.

- Make certain all nuts and bolts are tightened securely.

INSTALLING THE MULCHING BAFFLE

- Lift the chute deflector on the mower. Slide the notches in the bottom of the mulching baffle over the lip of the discharge opening. See Figure 10.

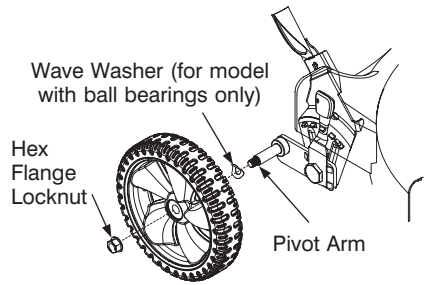

Figure 7 - Rear Wheel

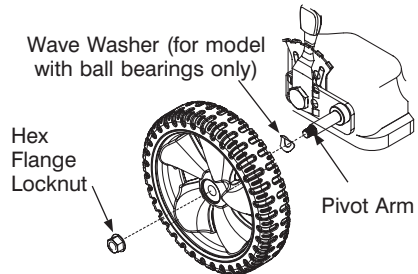

Figure 8 - Front Wheel

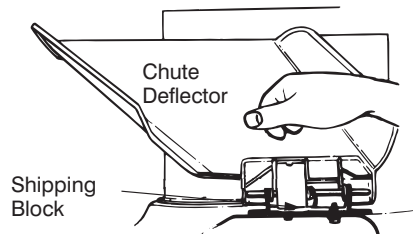

Figure 9

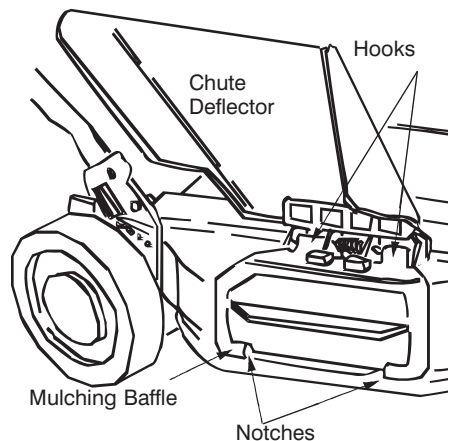

Figure 10

- Push the hooks on the top of the baffle until they snap over the hinge on the discharge chute. Release the chute deflector.

NOTE: When you wish to mow instead of mulch, simply raise the chute deflector, grasp the handle on the mulching baffle and lift upward to remove the baffle. It is not necessary to remove the mulching blade.

OPERATION

Service the engine with gasoline and oil as instructed in the separate engine manual packed with your mower. Read instructions carefully.

WARNING: Never fill fuel tank indoors, with engine running or until the engine has been allowed to cool for at least two minutes after running.

TO START ENGINE AND ENGAGE BLADE

- Attach spark plug wire to spark plug. If unit is equipped with a rubber boot over the end of the spark plug wire, make certain the metal loop on the end of the spark plug wire (inside the rubber boot) is fastened securely over the metal tip on the spark plug. See Figure 11.



Figure 11

- If your unit is equipped with a primer, prime engine as instructed in the separate engine manual packed with your unit.
- Standing behind the unit, depress the blade control handle and hold it against the upper handle as shown in Figure 11.
- Grasp the recoil starter handle as shown and pull slowly until resistance is felt, then pull rapidly to start engine and avoid kickback. Return it slowly to the rope guide bolt.

The blade control handle must be depressed in order to operate the unit. Release the blade control handle to stop the engine and blade.

WARNING: THIS CONTROL MECHANISM IS A SAFETY DEVICE. NEVER ATTEMPT TO BYPASS ITS OPERATIONS.

TO STOP ENGINE:

- Release the blade control handle to stop the engine and blade.

WARNING: The blade continues to rotate for a few seconds after the engine is shut off.

- Disconnect the spark plug wire and ground it against the engine to prevent accidental starting while equipment is unattended.

USING YOUR MULCHER (Optional)

Mulching mowers use a specially designed blade to chop the grass clippings extra fine and then blow them back down into the lawn. The small clippings decompose quickly becoming a natural fertilizer that returns much of the needed nutrients to the soil. Continuous mulching means continuous free natural fertilization, no messy clippings to worry about ever again and the end result for you is a much greener healthier lawn.

WARNING: Your mower is designed to cut normal residential grass of a height no more than 10". Do not attempt to mow through unusually tall, dry grass (e.g., pasture) or piles of dry leaves. Debris may build up on the mower deck or contact the engine exhaust presenting a potential fire hazard.

FOR THE BEST RESULTS WHEN MULCHING:

- **Clear lawn of debris.** Be sure that the lawn is clear of stones, sticks, wire or other foreign objects which could damage the lawnmower. Such objects could be accidentally thrown out by the mower in any direction and cause serious personal injury to the operator and others as well as damage to property and surrounding objects.
- **Do not cut wet grass.** For effective mulching do not cut wet grass because it tends to stick to the underside of the deck preventing proper mulching of the grass clippings.
- **Cut no more than 1/3 the length of the grass.** The recommended cut for mulching is 1/3 the length of the grass. Ground speed will need to be adjusted so the clippings can be dispersed evenly into the lawn. For especially heavy cutting in thick grass it may be necessary to use one of the slowest speeds in order to get a clean well mulched cut. When mulching long grass you may have to cut the lawn in two passes, lowering the blade another 1/3 of the length for the second cut and perhaps cutting in a different pattern than was used the first time. Over-

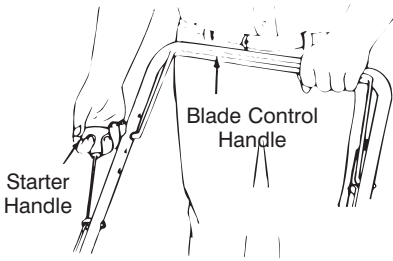

Figure 12

lapping the cut a little on each pass will also help to clean up any stray clippings left on the lawn. The mower should always be operated at full throttle to get the best cut and allow it to do the most effective job of mulching.

- **Clean underside of deck.** Be certain to clean the underside of the cutting deck after each use to avoid a build-up of grass, which would prevent proper mulching.
- **Mulching Leaves.** The mulching of leaves can also be beneficial to your lawn. When mulching leaves make sure they are dry and are not laying too thick on the lawn. Do not wait for all the leaves to be off the trees before you mulch.
- It is recommended keeping driveways and sidewalks on the operators right while mowing. Continue mowing using this pattern, having the left side of your lawnmower next to the uncut grass. Mulching with the cutting area of the mower on the lawn avoids grass clippings in undesirable areas.



WARNING: If you strike a foreign object, stop the engine. Remove wire from spark plug, thoroughly inspect the mower for any damage, and repair the damage before re-starting and operating the mower. Extensive vibration of the mower during operation is an indication of damage. The unit should be promptly inspected and repaired.

DECK

The underside of the mower deck should be cleaned after each use to prevent a buildup of grass clippings, leaves, dirt or other matter. If this debris is allowed to accumulate, it will invite rust and corrosion, and may prevent proper mulching.

The deck may be cleaned by tilting the mower and scraping clean with a suitable tool (make certain the spark plug wire is disconnected).

ADJUSTMENT

CAUTION: DO NOT AT ANY TIME MAKE ANY ADJUSTMENT TO LAWNMOWER WITHOUT FIRST STOPPING THE ENGINE AND DISCONNECTING THE SPARK PLUG WIRE.

CAUTION: Before changing mowing height stop mower and disconnect spark plug cable.

MODELS WITH NINE POSITION HEIGHT ADJUSTERS: (See Figure 13).

- Stop mower and disconnect spark plug cable before changing mower cutting height.
- The wheel adjusters give you nine (9) different cutting positions. Medium is the best for most mowers.
- To change the height of cut, squeeze adjuster lever toward the wheel, moving up or down to selected height.

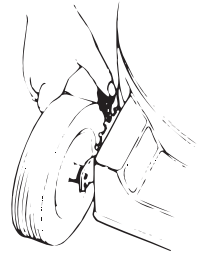

Figure 13

NOTE: All wheels must be in the same height of cut.

- When cutting in heavy or moist grass, the rear of lawnmower may be raised higher to allow better discharge of the grass.

CARBURETOR ADJUSTMENT

Minor carburetor adjustment may be required to compensate for differences in fuel, temperature, altitude and load. Refer to the separate engine manual packed with your mower for carburetor adjustment information.

HANDLE HEIGHT ADJUSTMENT

Your mower has provisions for two handle height positions. The notch on the flat portion of the lower handle indicates which position the handle is in. If the notch is facing up or forward the handle is in the lower height and for the higher height the notch is facing down.

To change the height setting refer to "Attaching the Lower Handle" on page 7.

LUBRICATION

CAUTION: DISCONNECT SPARK PLUG WIRE BEFORE SERVICING.

WHEELS - If your mower is equipped with ball bearing wheels, lubricate at least once a season with a light oil, all other types require no lubrication. However, if the wheels are removed for any reason, lubricate the surface of the axle bolt and the inner surface of the wheel with light automotive oil.

ENGINE - Follow engine manual for lubrication instructions.

BLADE CONTROL - Lubricate the pivot points on the blade control handle and the brake cable at least once a season with light oil. The blade control must operate freely in both directions.

MAINTENANCE

CUTTING BLADE



WARNING: Be sure to disconnect and ground the spark plug wire and remove ignition key before working on the cutting blade to prevent accidental engine starting. Protect hands by using heavy gloves or a rag to grasp the cutting blade.

- Tip mower as specified in separate engine manual. If it is not specified tip with carburetor up.
- Remove the bolt and blade support which holds the blade and adapter to the engine crankshaft. Remove the blade and adapter from the crankshaft. See Figure 14.



WARNING: Periodically inspect the blade adapter for cracks, especially if you strike a foreign object. Replace when necessary.

For best results your blade should be sharp. The blade may be resharpened by removing it and either grinding or filing the cutting edge keeping as close to the original bevel as possible. Improper blade balance will result in excessive vibration causing eventual damage to the engine and mower. Be sure to carefully balance blade after sharpening.

CAUTION: Cutting grass in sandy soil condition causes abrasive wear to the blades.

After prolonged use, especially in sandy soil conditions, the blade will become worn and lose some of the original shape. Cutting efficiency will be reduced and the blade should be

replaced. Replace with an approved factory replacement blade only. Possible damage resulting from blade unbalance condition is not the responsibility of the manufacturer.

When sharpening the blades, follow the original angle of grind as a guide. It is **extremely important** that each cutting edge receives an equal amount of grinding to prevent an unbalanced blade.

The blade can be tested for balance by balancing it on a round shaft screwdriver. Remove metal from the heavy side until it balances evenly.

Before reassembling the blade and the blade adapter to the unit, lubricate the engine crankshaft and the inner surface of the blade adapter with light oil.

Install the blade adapter on the crankshaft with the "star" away from the engine. Refer to Figure 14. Place the blade with the side marked bottom (or with part number) facing away from the adapter. Align the blade bell support over the

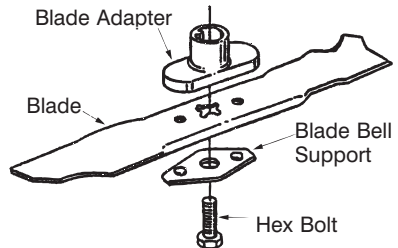

Figure 14

blade with the tabs in the holes of the blade and insert the hex bolt. Tighten the hex bolt to the torque listed below:

Blade Mounting Torque

Center Bolt 450 in. lb. min., 600 in.lb. max.

To insure safe operation of your unit, ALL nuts and bolts must be checked periodically for correct tightness.

CAUTION: Cutting grass in sandy soil condition causes abrasive wear to the blades.

ENGINE

Refer to the separate engine manual for engine maintenance instructions.

Maintain **engine oil** as instructed in the separate engine manual packed with your unit. Read and follow instructions carefully.

Under normal conditions service **air cleaner** as instructed in the separate engine manual packed with your unit. Clean every few hours under extremely dusty conditions. Poor engine performance and flooding usually indicates that the air cleaner should be serviced.

The **spark plug** should be cleaned and the gap reset once a season. Spark plug replacement is recommended at the start of each mowing season; check engine manual for correct plug type and gap specifications.

NOTE: *This spark ignition system meets all requirements of the Canadian Interference-Causing Equipment Regulations.*

Clean the engine regularly with a cloth or brush. Keep the cooling system (blower housing area) clean to permit proper air circulation which is essential to engine performance and life. Be certain to remove all grass, dirt and combustible debris from muffler area.

OFF SEASON STORAGE INSTRUCTIONS

The following steps should be taken to prepare lawn mower for storage.

- Clean and lubricate mower thoroughly as described in the lubrication instructions.
- Refer to engine manual for correct engine storage instructions.
- Coat mower's cutting blade with chassis grease to prevent rusting.
- Store mower in a dry, clean area.

NOTE: *When storing any type of power equipment in an unventilated or metal storage shed, care should be taken to rust-proof the equipment. Using a light oil or silicone, coat the equipment, especially cables and all moving parts.*

NOTE: *Be careful not to bend or kink cables.*

NOTE: *If the starter rope becomes disconnected from rope guide on handle, disconnect and ground the spark plug wire. Depress the blade control handle and pull the starter rope out from engine slowly. Slip the starter rope into the rope guide bolt on handle.*

THREE (3) YEAR LIMITED WARRANTY

For three (3) years from the date of original purchase of our products, we will either repair or replace, at its option, free of charge, F.O.B. Factory or authorized service firm, any part found to be DEFECTIVE IN MATERIAL and WORKMANSHIP for the original purchaser. all transportation charges on parts submitted for replacement under this warranty must be paid by the purchaser unless return is requested by the manufacturer.

This warranty DOES NOT apply to any part which has become inoperative through misuse, excessive use, accident, neglect, improper maintenance or alterations by unauthorized persons.

The limited warranty does not extend to the replacement of parts which are not defective, but where regular usage has exhausted the life of the part.

ENGINES, ELECTRIC START KITS, PEERLESS TRANSMISSIONS AND PEERLESS TRANSAXLES ARE WARRANTED BY THEIR RESPECTIVE MANUFACTURER. ALL CLAIMS AGAINST THESE COMPONENTS MUST BE HANDLED THROUGH THE RESPECTIVE MANUFACTURER'S SERVICE DEALERS.

Belts, light bulbs, clutch parts (friction wheels), grass bags, tires, seats, rider deck wheels and cutting blades are covered by a 60 day limited warranty.

Batteries are covered by a 90 day limited warranty.

Fuses, shear bolts and blade adapters are considered consumable items and as such are not warranted.

NOTE: Regular maintenance replacement parts and related inspections and adjustments are excluded from coverage when made as part of normal maintenance service.

TRACTOR ATTACHMENT WARRANTY

Mower decks included with your product, or sold separately, as an attachment for your garden tractors will be warranted according to the above terms of the manufacturer three (3) year limited consumer warranty.

ALL OTHER ATTACHMENTS will be sold under the same condition as above except the warranty will be ONE YEAR FROM DATE OF ORIGINAL PURCHASE.

PERSONAL USE

THE FOREGOING PARAGRAPHS CONSTITUTE THE MANUFACTURER'S ENTIRE WARRANTY WITH RESPECT TO ANY PRODUCT PURCHASED AND USED FOR PERSONAL FAMILY, HOUSEHOLD/RESIDENTIAL PURPOSES, AS DISTINGUISHED FROM COMMERCIAL USAGE.

COMMERCIAL USE

ALL APPLICATIONS OTHER THAN PERSONAL USE AS OUTLINED ABOVE, ARE CONSIDERED COMMERCIAL USAGE.

New products purchased for commercial usage are warranted in the same manner and to the same extent EXCEPT the term of warranty will be 60 DAYS from date of purchase.

WARRANTY SERVICE CAN ONLY BE PERFORMED BY AN AUTHORIZED SERVICE DEALER. ANY NON-ORIGINAL EQUIPMENT REPLACEMENT PART USED ON OR IN A PRODUCT UNDER WARRANTY WILL BE EXCLUDED FROM THAT WARRANTY COVERAGE, AS WILL BE ANY RELATED DAMAGED COMPONENTS RESULTING FROM THE INSTALLATION OF A REPLACEMENT PART FROM ANOTHER SOURCE OTHER THAN THE MANUFACTURER.

notes . . .